



ENS SALLE A MANGER - 5PCS / METAL NOIR ET DESSUS

DINING SET - 5PCS SET / BLACK METAL AND TOP

I 1018

**INSTRUCTIONS D'ASSEMBLAGE
ASSEMBLY INSTRUCTIONS**









**POUR DE L'ASSISTANCE OU POUR COMMANDER
DES PIÈCES CONTACTEZ NOTRE DÉPARTEMENT
DE SERVICE À LA CLIENTÈLE.**

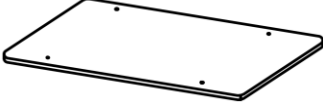
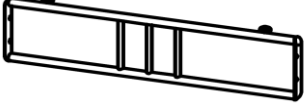
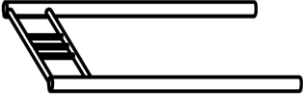
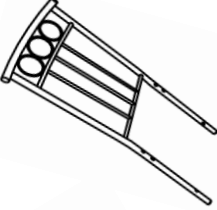





**FOR ASSISTANCE OR TO ORDER PARTS
CONTACT OUR CUSTOMER SERVICE DEPARTMENT**

WWW.MONARCHSERVICE.COM

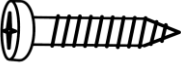
IDENTIFICATION DES PIÈCES
PARTS IDENTIFICATION

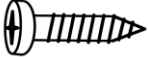
1		DESSUS DE TABLE TABLE TOP	1MC 1PC
2		SOUTIEN DE PATTE LEG SUPPORT	2MCX 2PCS
3		PATTE LEG	2MCX 2PCS
4		DOSSIER DE CHAISE CHAIR BACK	4MCX 4PCS
5		PATTE DE CHAISES GAUCHE LEFT CHAIR LEG	4MCX 4PCS
6		PATTE DE CHAISES DROITE RIGHT CHAIR LEG	4MCX 4PCS
7		BARRE TRANSVERSALE DU SIÈGE SEAT CROSS BAR	4MCX 4PCS
8		BARRE TRANSVERSALE DE PATTE CROSS BAR (CHAIR)	4MCX 4PCS
9		BARRE TRANSVERSALE DE PATTE CROSS BAR (CHAIR)	4MCX 4PCS
10		SIÈGE COUSSINE CUSHION SEAT	4MCX 4PCS

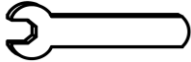
IDENTIFICATION DES PIÈCES DE MONTAGE
HARDWARE IDENTIFICATION

A		Ø1/4" X 32MM	16MCX / 16PCS
B		Ø1/4" X 12MM	32MCX / 32PCS
C		Ø1/4" X 35MM	16MCX / 16PCS
D		Ø1/4" X 12MM	4MCX / 4PCS
E		Ø1/4" X 15MM	4MCX / 4PCS
F		ÉCROU HEXAGONAL 1/4" 1/4" HEX NUT	4MCX / 4PCS
G		CLÉ OUVERTE SPANNER	1MC / 1PC
H		M4	1MC / 1PC

ÉTAPE / STEP 1

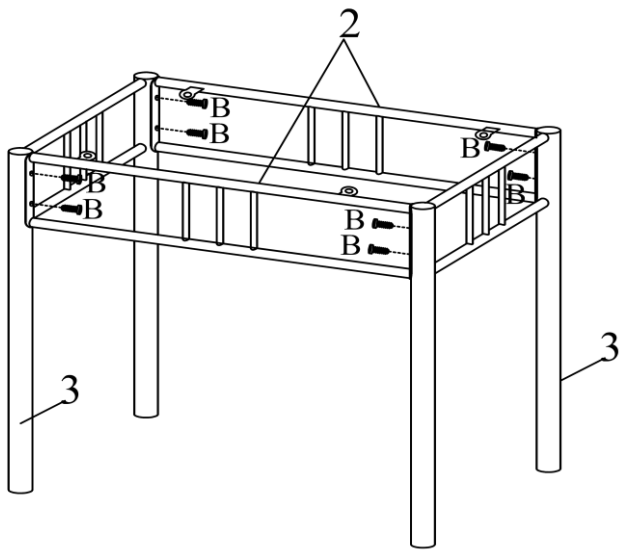

ÉTAPE / STEP 2

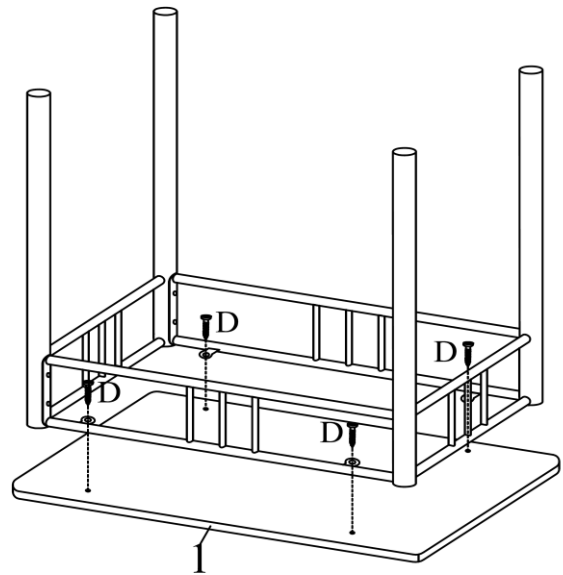

ÉTAPE / STEP 3

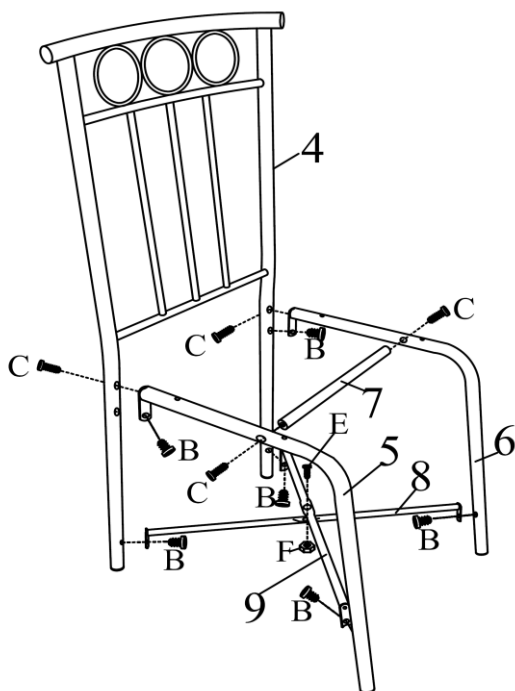

ÉTAPE / STEP 4

