



**TABLE D'APPOINT - 36"L / CONSOLE
D'ENTREE CAPPUCINO**

**ACCENT TABLE - 36"L / CAPPUCINO HALL
CONSOLE**

I 2450

**INSTRUCTIONS D'ASSEMBLAGE
ASSEMBLY INSTRUCTIONS**



**POUR DE L'ASSISTANCE OU POUR COMMANDER
DES PIÈCES CONTACTEZ NOTRE DÉPARTEMENT
DE SERVICE À LA CLIENTÈLE.**







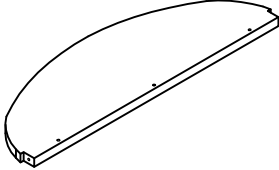
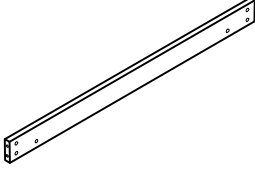
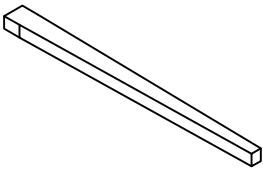
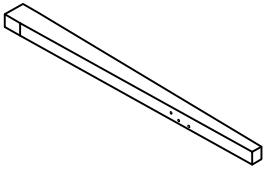
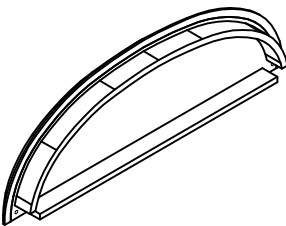
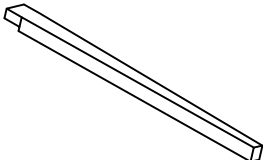







**FOR ASSISTANCE OR TO ORDER PARTS
CONTACT OUR CUSTOMER SERVICE DEPARTMENT**

WWW.MONARCHSERVICE.COM

IDENTIFICATION DES PIÈCES
PARTS IDENTIFICATION

1		PANNEAU DE TABLETTE SHELF PANEL	1MC/PC
2		BARRE TRANSVERSALE CROSSBAR	1MC/PC
3		PATTE ARRIÈRE GAUCHE REAR LEFT LEG	1MC/PC
4		PATTE ARRIÈRE DROITE REAR RIGHT LEG	1MC/PC
5		PANNEAU DU DESSUS TOP PANEL	1MC/PC
6		PATTE DEVANT FRONT LEG	2MCX/PCS

IDENTIFICATION DES PIÈCES DE MONTAGE
HARDWARE IDENTIFICATION

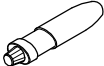
A		M6×30mm	6MCX/PCS
B		M8×70mm	4MCX/PCS
C		M8	4MCX/PCS
D		M8	4MCX/PCS
E		Ø45mm	2MCX/PCS
F		L=29mm	8MCX/PCS
G		Ø15mm	8MCX/PCS
H		Ø8×25mm	1MC/PC
I		Ø16mm	4MCX/PCS
J		M13	1MC/PC
K		Ø4×25mm	1MC/PC
L		Ø5×40mm	1MC/PC
M		Ø8×40mm	1MC/PC
N		200×12mm	1MC/PC
O		COLLE/GLUE	1MC/PC

ÉTAPE / STEP 1

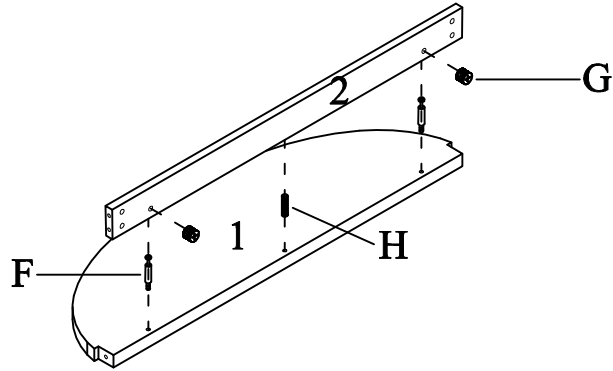

ÉTAPE / STEP 2

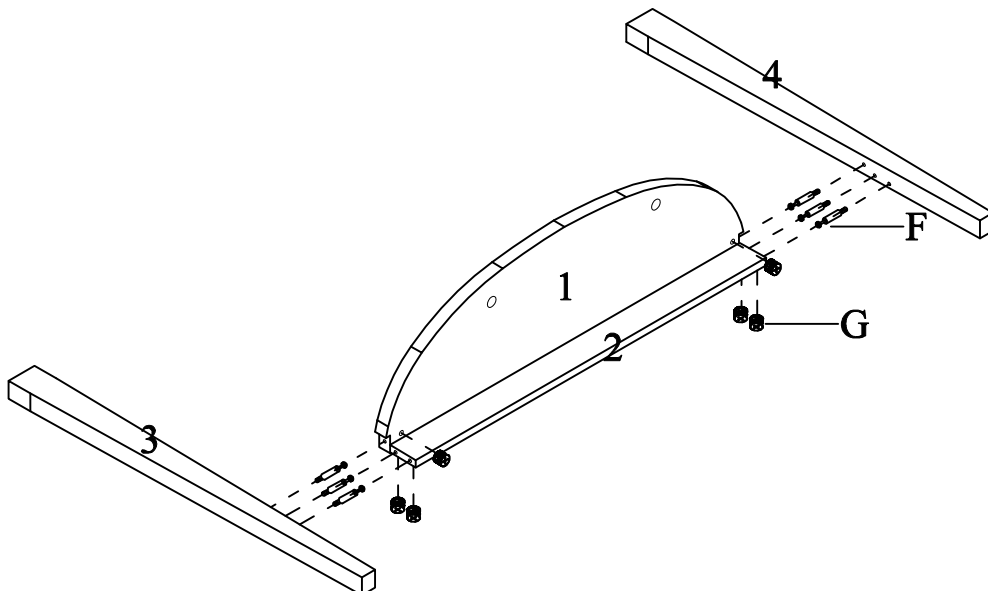

ÉTAPE / STEP 3

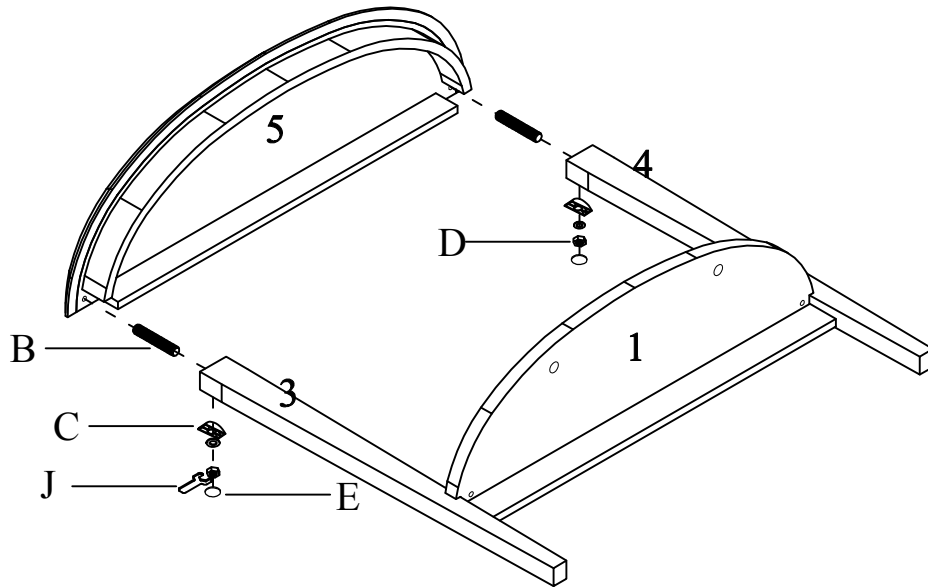

ÉTAPE / STEP 4

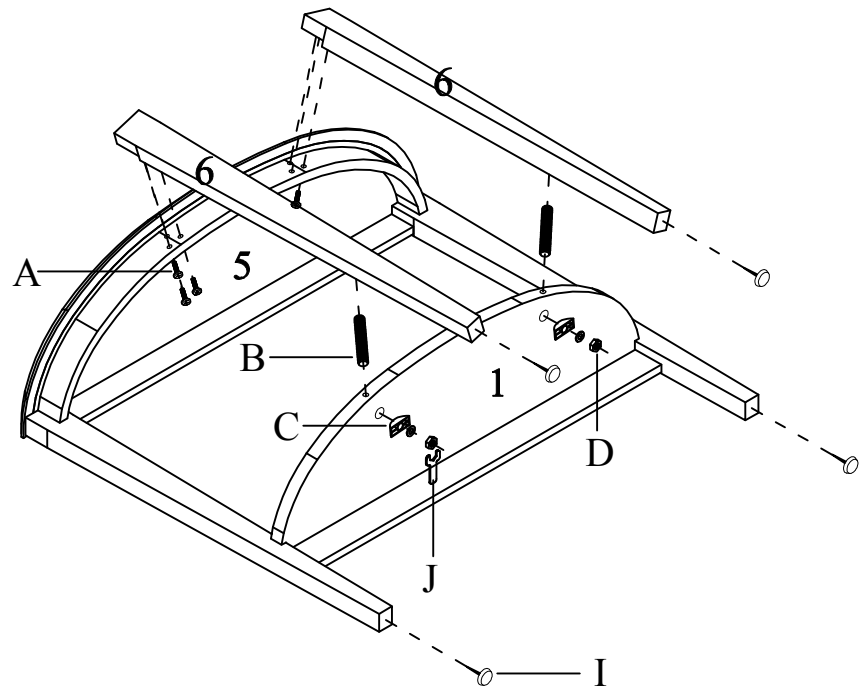

ÉTAPE / STEP 5

